



LIVE THE BRAAI LIFE

2022 PRODUCT RANGE

www.cadacinternational.com



URBAN RANGE



TABLE OF CONTENTS

URBAN BBQ'S

E BRAAI	4
Citi Chef 40	6
Citi Chef 40 FS	7
Citi Chef 50	10

PATIO BBQ'S

Meridian Built-In	14
-------------------------	----

CAMPING BBQ'S

Safari Chef 30	19
Grillo Chef 40	24
Carri Chef 50	27
2-Cook 2	31
Braai Range	34

GAS SUPPLY

Power Pak Supply	41
CADAC Regulators	42
Quick Release Coupling	44
CADAC Cartridges	45

ACCESSORIES

Product Accessories	46
General Accessories	50

PRODUCT SPECIFICATIONS

Product Specifications	58
------------------------------	----

* REFER TO PAGE 58-63 FOR ALL
PRODUCT SPECS AND CODES

E BRAAI



Colour options:



Petrol



Black

5840-20

⚡ 2.3 kW

📏 48 x 35.5 x 44.5 cm

📦 10.1 kg

📏 ø 39 cm BBQ Top

📦 8 kg

📦 53 x 53 x 33 cm



With the Auto Temperature grill setting you can set the grill cooking temperature exactly.



- Easy-clean, ceramic coated GreenGrill cooking top.
- Easy-clean removable, dishwasher safe fat pan.



- Electric 2.3 kW heat coil for quick heat up time.
- Heat coils are protected from fat dripping onto them by removable and washable glass ring.



- Optional CADAC modular accessories for pizza and paella cooking.
- Pot stand included.



AUTO GRILL TEMPERATURE CONTROL

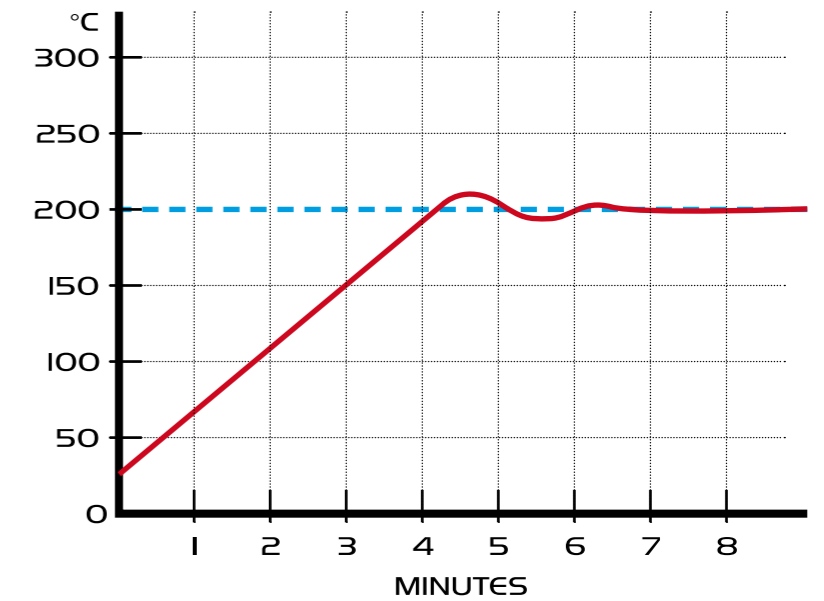

— ACTUAL GRILL TEMPERATURE
 - - SET CONTROL TEMPERATURE



- 4 dome vents allow air to flow through the BBQ for even-heat cooking grill.
- Good outdoor performance on camp site with little wind effect on heat coils.



Bag for storage or transport included.

CITI CHEF 40



Colour options:



Olive Green



Sky Blue



Black

FEATURES

- Single high performance burner that gives even heat and quick heat up time
- Automatic piezo ignition
- Easy-clean, GreenGrill ceramic coated barbecue grill
- Easy-clean, porcelain enamelled removable fat pan
- Four stable, non-slip feet
- Dome with thermometer
- Pot stand included
- Storage bag included

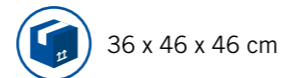
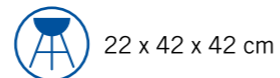

CITI CHEF 40 FS

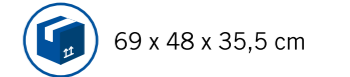
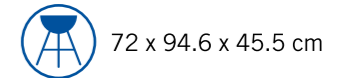
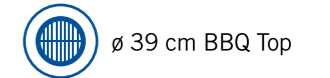

FEATURES

- Single high performance burner that gives even heat and quick heat up time
- Automatic piezo ignition
- Easy-clean, GreenGrill ceramic coated barbecue grill
- Removable side tables
- Easy-clean, Porcelain enamelled removable fat pan
- Pot stand included
- Dome with thermometer
- Condiment tray for extra storage
- Tray also holds CADAC Dual & Trio Power Pak for LP gas cartridge options

Colour options:



Black



Flint Grey

CHEF 40 MODULAR COOKING OPTIONS



8600-100
PAELLA PAN 40

- Size: ø 36 cm
- Thick aluminium GreenGrill non-stick ceramic coated pan
- Easy to clean
- Storage bag included

NEW!

5610-400
GRILL 2 BRAAI 40

- Size: ø 38 cm
- GreenGrill Ceramic non-stick coated surface
- Easy to clean
- Half flat plate / half ribbed grill
- Storage bag included



5610-300
CHEF PAN 40

- Size: ø 36 cm
- GreenGrill ceramic non-stick coated surface
- Can be used on a gas or electric hob
- Storage bag included



5610-200
BBQ/PLANCHA 40

- Size: ø 38 cm
- GreenGrill Ceramic non-stick coated surface
- Easy to clean
- Half grill / half flat plate
- Storage bag included

98433
PIZZA STONE PRO 40

- Size: ø 33 cm
- 1,2 cm thick baking stone
- Can withstand temperatures of 300°C +
- Heat distributor tray for optimal performance
- Storage bag included



CITI CHEF 50



- # 20162-20
- ø 46 cm BBQ Top
- 270 g/h
- 3.7 kW
- 20 kg
- 88 x 55 x 105 cm
- 76 x 66 x 38 cm
- 24 kg

FEATURES

- High performance burner that gives even heat and quick heat up time
- Automatic piezo ignition
- Easy-clean, porcelain enamelled fat pan and removable fat cup/fat pan
- Removable bamboo side tables
- Easy-clean, ceramic GreenGrill barbecue grill
- Dome with thermometer
- Discrete gas cylinder storage
- 4 locking castor wheels
- Two hanging hooks

CHEF 50 MODULAR COOKING OPTIONS



- 8910-105
ROAST PAN 50
- Size: ø 37 cm
 - Enameled
 - Easy to clean
 - Storage bag included

- 5758
PAELLA PAN 50
- Size: ø 47 cm
 - Thick aluminium GreenGrill non-stick ceramic coated pan
 - Easy to clean
 - Storage bag included



- 8910-102
CHEF PAN 50
- Size: ø 45 cm
 - GreenGrill ceramic non-stick coated surface
 - Can be used on a gas or electric hob
 - Storage bag included



8910-100

GRILL 2 BRAAI 50

- Size: ø 45 cm
- GreenGrill Ceramic non-stick coated surface
- Easy to clean
- Half flat plate / half ribbed plate
- Storage bag included

98436

PIZZA STONE PRO 50

- Size: ø 36 cm
- 1,2 cm thick baking stone
- Can withstand temperatures of 300°C +
- Heat distributor tray for optimal performance
- Storage bag included



8910-108

BBQ/PLANCHA 50

- Size: ø 46 cm
- GreenGrill Ceramic non-stick coated surface
- Easy to clean
- Half grill / half flat plate
- Storage bag included











MERIDIAN BUILT-IN 3B



FEATURES

- 3 Burner BBQ
- Double skinned dome
- Thermometer on dome
- Stainless steel burners with automatic piezo ignition
- 3 Flame tamers
- 3 ThermoGrills and warmer rack
- Easily accessible removable fat tray
- Modular system compatible
- Easy to move with grips on the side of BBQ









 982231	 27 kg
 63,5 x 48,5 cm	 71,5 x 55 x 51 cm
 699 g/h	 75,9 x 63,5 x 55,5 cm
 9.6 kW	 30 kg

MERIDIAN BUILT-IN 4B



FEATURES

- 4 Burner BBQ
- Double skinned dome
- Thermometer on dome
- Stainless steel burners with automatic piezo ignition
- 4 Flame tamers
- 3 ThermoGrills and warmer rack
- Easily accessible removable fat tray
- Modular system compatible
- Easy to move with grips on the side of BBQ

 982241	 31 kg
 80 x 48,5 cm	 87,5 x 55 x 51 cm
 902 g/h	 90,9 x 63,5 x 55,5 cm
 12.4 kW	 35 kg

MERIDIAN MODULAR COOKING OPTIONS



98394
MERIDIAN BAKING STONE

- Size: 26.5 x 48 cm
- 1 cm thick
- Temperature limit: 500°C



98507
MERIDIAN WARMER PAN

- Size: 26.5 cm x 42 cm
- Material: solid aluminium with GreenGrill ceramic coating inside pan
- Non-stick interior & scratch resistant

98331
42CM PIZZA STONE

- Size: ø 42 cm
- 1.5 cm thick baking stone
- Can withstand temperatures of 300°C
- Includes chrome plated wire holder

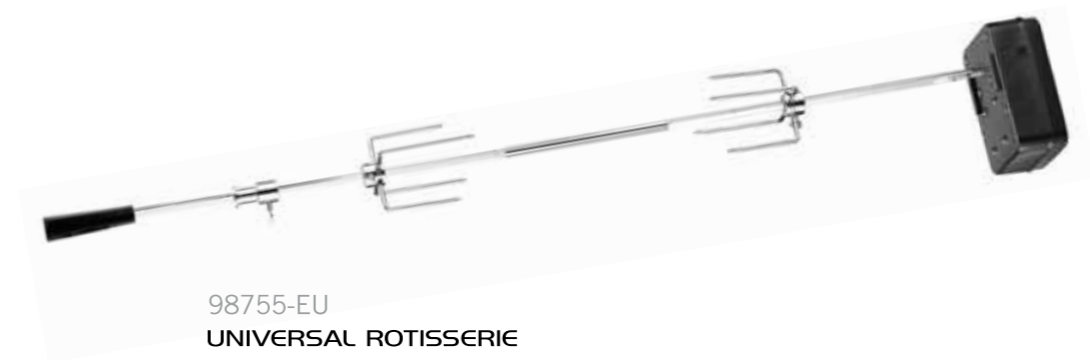

98755-EU
UNIVERSAL ROTISSERIE

- Universal rotisserie for Meridian & Entertainer range of gas barbecues
- Battery driven



NEW!

SAFARI CHEF COMPACT 30



CAMPING RANGE



FEATURES

- Compact & lightweight
- Easy-clean, GreenGrill ceramic coated BBQ grid
- Enameled Pot / Lid
- Stainless steel burner
- Automatic push button piezo ignition and gas control valve
- Chromed pot stand included
- Carry bag included
- Flat grill included - ideal for frying
- Dome can be used as pot

- # 6525L1-10-UN
- ∅ 28 cm BBQ Top
- ∅ 26 cm Flat Grill
- ∅ 27 cm Dome / Pot
- 132 g/h
- 1.82 kW
- 3,8 kg
- 23 x 34.7 x 30.4 cm
- 5,2 kg

PLEASE NOTE THAT PRODUCTS MAY VARY FROM ILLUSTRATIONS

NEW!

SAFARI CHEF COMPACT 30 LITE

6525L1-20-UN

Pot stand, BBQ Grid & Dome



SAFARI CHEF 30



FEATURES

- Easy-clean, GreenGrill ceramic coated BBQ grid
- Enameled Pot / Lid
- Foldable legs
- Stainless steel burner
- Automatic push button piezo ignition and gas control valve
- Chromed pot stand included
- Carry bag included
- Flat grill included - ideal for frying
- Dome can be used as pot

6540H1-10 (HP)

ø 28 cm BBQ Top

ø 26 cm Flat Grill

ø 27 cm Dome / Pot

132 g/h

1.82 kW

4 kg

30 x 36 x 42 cm

33 x 33 x 23.5 cm

5.2 kg

PLEASE NOTE THAT PRODUCTS MAY VARY FROM ILLUSTRATIONS

PLEASE NOTE THAT PRODUCTS MAY VARY FROM ILLUSTRATIONS

6540L1-10 (Low Pressure)

Pot stand, BBQ Grid, Flat Grill & Dome



6540H1-10 (High Pressure)

Pot stand, BBQ Grid, Flat Grill & Dome



6540L1-20 (Low Pressure - Lite)

Pot stand, BBQ Grid & Dome



6540H1-20 (High Pressure - Lite)

Pot stand, BBQ Grid & Dome



CHEF 30 MODULAR COOKING OPTIONS



8635
PAELLA PAN 30

- Size: ø 28 cm
- Thick aluminium GreenGrill ceramic coated non-stick pan
- Stainless steel lid included
- Easy to clean
- Storage bag included

98425
PIZZA STONE PRO 30

- Size: ø 25 cm
- 1,2 cm thick baking stone
- Can withstand temperatures of 300°C +
- Heat distributor tray for optimal performance
- Storage bag included



6540-600
BBQ/PLANCHA 30

- Size: ø 28 cm
- Half grill / half flat plate
- GreenGrill Ceramic coated top
- Easy to clean
- Storage bag included

GRILLO CHEF 40



FEATURES

- BBQ Grid with GreenGrill ceramic coating
- Pot stand included
- Dome with thermometer
- Stainless steel stem
- Gas control knob
- Easy to clean, removable fat pan
- Automatic push button piezo ignition
- Removable aluminium legs
- Dome with thermometer

5650-20

∅ 38 cm BBQ grid
Pot stand

218 g/h

3 kW

8 kg

65.4 x 65.4 x 88.5 cm

42.2 x 15 x 57.3 cm

9 kg



5650-41

Dome, Chef Pan, BBQ Grid
& Pot stand



CHEF 40 MODULAR COOKING OPTIONS



- 5610-200
BBQ/PLANCHA 40**
- Size: ø 36 cm
 - GreenGrill ceramic non-stick coated surface
 - Easy to clean
 - Half grill / half flat plate
 - Storage bag included

- 5610-300
CHEF PAN 40**
- Size: ø 36 cm
 - GreenGrill ceramic non-stick coated surface
 - Can be used on a gas or electric hob
 - Storage bag included



- 8600-100
PAELLA PAN 40**
- Size: ø 36 cm
 - Thick aluminium GreenGrill ceramic non-stick coated pan
 - Easy to clean
 - Can be used on an a gas or electric hob
 - Storage bag included

NEW!

- 5610-400
GRILL 2 BRAAI 40**
- Size: ø 38 cm
 - GreenGrill Ceramic non-stick coated surface
 - Easy to clean
 - Half flat plate / half ribbed grill
 - Storage bag included



- 98433
PIZZA STONE PRO 40**
- Size: ø 33 cm
 - 1,2 cm thick baking stone
 - Can withstand temperatures of 300°C +
 - Heat distributor tray for optimal performance
 - Storage bag included

CARRI CHEF 50

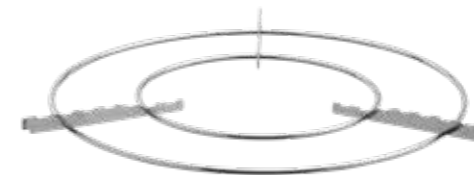

FEATURES

- BBQ grid with GreenGrill ceramic non-stick coating
- Automatic push button Piezo ignition
- Porcelain enameled dome with thermometer
- Heat-resistant dome handle
- Condiment tray for extra storage
- Easy-clean, porcelain enameled fat pan
- Screw-on leg clamps
- Light-weight anodised aluminium legs
- English recipe book included
- Storage and carry bag included

8910-20

ø 46 cm BBQ Top
Pot Stand

270 g/h

3,7 kW

12 kg

69.6 x 69.6 x 93.4 cm

32.7 x 56.6 x 57.2 cm

15 kg

8910-50

Dome, BBQ Grid, Grill 2 Braai & Pot stand



8910-80

Dome, BBQ/Plancha & Pot stand



8910-30

Dome, Skottel® Top, BBQ Grid & Pot stand



8910-40

Dome, Chef Pan, BBQ Grid & Pot stand



CHEF 50 MODULAR COOKING OPTIONS



5758
PAELLA PAN 50

- Size: ø 47 cm
- Thick aluminium GreenGrill ceramic non-stick coated pan
- Easy to clean
- Can be used on an a gas or electric hob
- Storage bag included

8910-100
GRILL 2 BRAAI 50

- Size: ø 45 cm
- GreenGrill ceramic non-stick coating
- Ribbed grill BBQ on one side and flat grill on the other
- Storage bag included



8910-103
SKOTTEL® TOP 50

- Size: ø 48.6 cm
- Hard porcelain enamel coating
- Stay-cool handles
- Ideal for wok-style cooking, stir-fries, pasta dishes, sauces and breakfasts
- Storage bag included

8910-102
CHEF PAN 50

- Size: ø 45 cm
- GreenGrill ceramic non-stick coated surface
- Can be used on a gas or electric hob
- Storage bag included



2 COOK 2 PRO DELUXE



- 8910-105
ROAST PAN 50
- Size: ø 37 cm
 - Hard porcelain enamel coating
 - Ideal for or preparing roast chicken, lamb, vegetables etc
 - Storage bag included

- 98436
PIZZA STONE PRO 50
- Size: ø 36 cm
 - 1,2 cm thick baking stone
 - Can withstand temperatures of 300°C +
 - Heat distributor tray for optimal performance
 - Storage bag included

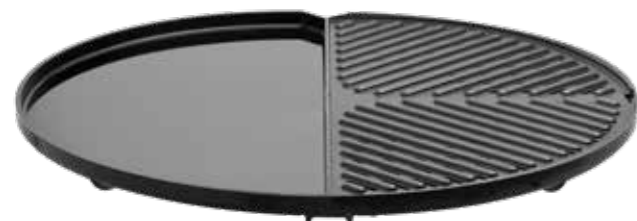

- 8910-108
BBQ/PLANCHA 50
- Size: ø 45 cm
 - GreenGrill ceramic non-stick coated surface
 - Easy to clean
 - Open grill BBQ with drainage holes on one side and flat grill on the other
 - Storage bag included



FEATURES

- Stainless steel stove
- Lockable lid
- Push button piezo ignition per burner
- GreenGrill ceramic coated non-stick grill plates included
- Easy clean stove
- Non-slip rubber feet
- Convenient carry bag included
- Independent cooking left/right sides









#	202P1-20	KG	4,85 kg
🔥	2x 25 x 25 cm	📏	57 x 34 x 31 cm
⚡	291 g/h	📦	58 x 31 x 16 cm
⚡	4 kW	KG	6,5 kg

2 COOK 2 CLASSIC



FEATURES

- Lightweight, portable stove
- Porcelain enamel coated pot stands
- Lockable lid
- Non-slip rubber feet
- Independent cooking left/right sides
- Grill plates sold as accessory

 202MO-10	 3,25 kg
 2x 25 x 25 cm	 57 x 34 x 31 cm
 291 g/h	 58 x 31 x 12 cm
 4 kW	 4,35 kg

2 COOK 2 MODULAR COOKING OPTIONS



- 202-300 RIBBED GRILL PLATE**
- Size: 25 cm x 25 cm
 - Ribbed Grill Plate can be used for grilling meats e.g. steaks, fish and hamburger patties
 - GreenGrill Ceramic non-stick coated grill
 - Includes storage bag



- 8635 PAELLA PAN 30**
- Size: ø 28 cm
 - Thick aluminium GreenGrill ceramic coated non-stick pan
 - Stainless steel lid included
 - Easy to clean
 - Storage bag included

- 202-200 FLAT GRILL PLATE**
- Size: 25 cm x 25 cm
 - The Flat Grill Plate is ideal for pancakes, eggs with bacon, etc.
 - GreenGrill Ceramic non-stick coated grill
 - Includes storage bag

SKOTTEL BRAAI



BRAAI RANGE



FEATURES

- Hard porcelain enamel-coated Skottel® dish
- Stainless steel handles
- Pot stand included
- Stainless steel stem
- Removable aluminium legs / easy to pack
- Convenient carry bag included

8309-10

Ø 48.6 cm Skottel® Top
Pot Stand

218 g/h

3 kW

6,3 kg

62.9 x 62.9 x 72.5 cm

56,6 x 14,6 x 50,7 cm

7,15 kg

GRILL 2 BRAAI



FEATURES

- BBQ grid with GreenGrill ceramic non-stick coating
- Aluminium half flat and half grill plate
- Pot stand included
- Stainless steel stem
- Removable aluminium legs / easy to pack
- Convenient carry bag included

8309-20

Ø 45 cm Grill 2 Braai Top
Pot Stand

218 g/h

3 kW

5,9 kg

62,9 x 62,9 x 71,6 cm

56,6 x 13,6 x 46,7 cm

6,6 kg

PAELLA BRAAI



FEATURES

- Lightweight paella pan with GreenGrill ceramic non-stick coating
- Pot stand included
- Stainless steel stem
- Removable aluminium legs / easy to pack
- Convenient carry bag included

8309-30

Ø 47 cm Paella pan
Pot Stand

218 g/h

3 kW

6 kg

62,9 x 62,9 x 72,5 cm

56,6 x 14,6 x 50,7 cm

6,9 kg

BRAAI RANGE MODULAR COOKING OPTIONS



- 5758
PAELLA PAN 50
- Size: ø 47 cm
 - Thick aluminium GreenGrill ceramic non-stick coated pan
 - Easy to clean
 - Can be used on a gas or electric hob
 - Storage bag included



- 8910-100
GRILL 2 BRAAI 50
- Size: ø 45 cm
 - GreenGrill ceramic non-stick coating
 - Storage bag included

GAS SUPPLY OPTIONS FOR CAMPING RANGE



CADAC TRIO POWERPAK



REFILLABLE GAS CYLINDER



EN417 THREADED GAS CARTRIDGE
REGULATED TO 30/50 MBAR



227g CARTRIDGE



CADAC DUAL POWERPAK

GAS SUPPLY OPTIONS	SAFARI CHEF 30 LP	SAFARI CHEF 30 HP	SAFARI CHEF 30 COMPACT	GRILLO CHEF 40	CARRI CHEF 50	2 COOK 2	BRAAI RANGE
Trio PowerPak	✓			✓	✓	✓	✓
Dual PowerPak	✓			✓	✓	✓	✓
LPG Cylinder	✓	✓ (with use of Adapter set)		✓	✓	✓	✓
EN417 Threaded Gas Cartridge	✓	✓		✓	✓	✓	✓
227g Cartridge only			✓				

GAS SUPPLY

POWER PAK SUPPLY

The CADAC Trio Power Pak and the CADAC Dual Power Pak replace a gas cylinder and regulator. The Power Paks are lightweight, portable and easy to use. The regulator and hose is included. Once you fit the disposable cartridges to a CADAC Power Pak, the LP gas supplies (at 28mbar) the camping appliance or barbecue. The universal fitting on the end of the hose is a ¼" BSP left hand thread, so the Dual Power Pak or Trio Power Pak can be used with any brand of camping stove or barbecue.

CADAC PRODUCTS THAT CAN BE POWERED BY THE DUAL & TRIO POWER PAKS:

Citi Chef 50, Carri Chef 50, Citi Chef 40, Grillo Chef 40, Safari Chef 30, 2-Cook 2, Skottel® Braai, Grill2Braai and other gas stoves/barbecues.

- The Trio Power Pak is driven by 3x bayonet style nozzle valve cartridges of 227g each (not included). This amount of gas will feed a small appliance or barbecue for ± 6 hours.
- The Trio has a removable back cover. When this is unclipped, the 3 cartridges can be fitted and clipped into the valve.
- The hose is removable with a CADAC QR/Quick Release connector.
- All 3 cartridges supply gas at the same time, which assists in cold climates.
- Includes a convenient carry bag.

Code: 370

TRIO POWER PAK



DUAL POWER PAK



- The Dual Power Pak is driven by 2x 445g or 2x 500g EN417 threaded cartridges (not included).
- Each cartridge can be independently fitted and each gas cartridge feeds the appliance.
- 1kg gas will supply a small barbecue like the Safari Chef 30 for ± 10 hours.

Code: 346-10



NL REGULATOR

NL regulator and 0.85m hose with valve tail end. Includes 2 clamps.

Code: 8510 - 30mbar



CG OVERFLOW REGULATOR

Overflow regulator with valve tail piece suitable for CG cylinders. Pressure 30mbar. Includes 0.85m hose & 2 hose clamps. Overflow regulator automatically shuts off flow of gas if hose is damaged or if it leaks. Includes cylinder pressure gauge.

Code: 8515-OF

NL OVERFLOW REGULATOR

NL Overflow regulator and 0.85m hose with valve tail end. Includes 2 clamps. Overflow regulator automatically shuts off flow of gas if hose is damaged or if it leaks. Includes cylinder pressure gauge.

Code: 8510-OF - 30mbar



HP CYLINDER ADAPTOR & HOSE

High pressure (HP) regulator to power your HP appliance with a refillable LPG cylinder. With 0.85m hose and handwheel support.

Code: 8521 - NL



DE REGULATOR

DE regulator and 0.85m hose set with 1/4" BSP left hand outer thread.

Code: 8520 - 50mbar

DE OVERFLOW REGULATOR

DE Overflow regulator and 0.85m hose set with 1/4" BSP left hand outer thread. Overflow regulator automatically shuts off flow of gas if hose is damaged or if it leaks. Includes cylinder pressure gauge.

Code: 8520-OF - 50mbar



1.5M HOSE WITH QR

- For a safe connection of any 30mbar BBQ to the internal gas-system of your caravan/motorhome
- Quick, easy and safe (un)coupling to the external hinge of your caravan/motor home

Code: 8508



3M HOSE WITH QR

- For a safe connection of any 30mbar BBQ to the internal gas-system of your caravan/motorhome
- Quick, easy and safe (un)coupling to the external hinge of your caravan/motor home

Code: 8524



CG REGULATOR

Regulator with valve tail piece suitable for CG cylinders. Pressure 30mbar. Includes 0.85m hose & 2 hose clamps.

Code: 8515

28/30mbar:



THREADED CARTRIDGE REGULATOR ASSEMBLY

- Enables low pressure appliances to operate off EN417 gas cartridges. Simply screw onto the cartridge.
- The EN417 Regulator Assembly includes a hose, tailpiece and handwheel support.
- The regulator fits a ¼" BSP left hand threaded gas cartridge.

Code: 343 – 28/30mbar / Code: 344 – 50mbar

50mbar:



QR/QUICK RELEASE COUPLING

This coupling makes it easy to click on or unclick the gas hose to a camping appliance or barbecue. It has a self-sealing valve for safe usage. Leave the 2 connectors on the camping appliance or barbecue, and clip off/on the gas hose.

Code: 338



QR/QUICK RELEASE COUPLING 2

This coupling makes it easy to click on or unclick the gas hose to a camping appliance or barbecue & includes 2 male connectors.

Code: 338-1

90° QR/QUICK RELEASE COUPLING

This coupling makes it easy to click on or unclick the gas hose to a camping appliance or barbecue & includes 1x straight female connector and 1x 90° male connector. The connector can swivel through 360°. Especially suitable for appliances like the 2-Cook & Citi Chef 40.

Code: 338-2



TAILPIECE WITH HANDWHEEL

Valve tailpiece with a plastic handwheel to make (un)coupling the hose easy.

Code: 8154-27

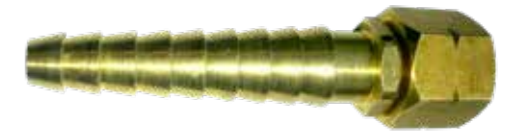

VALVE TAIL PIECE

Easy application due to anti-twist nut ensuring no hose distortion. Fits any 8mm gas hose pipe. Fits ¼" BSP left hand thread appliance.

Code: 8154-6

CARTRIDGES



445G & 500g THREADED VALVE CARTRIDGES

- Butane/Propane gas mix cartridge, fitted with standard type EN417 threaded self-sealing safety valve.
- The threaded cartridge screws directly onto a CADAC Safari Chef 30 HP or any other appliance with standard EN417 fitting.
- Ideal for home use, camping, fishing, picnicking or hiking.

Code: CA445 Weight: 645g when full

Code: CA500 Weight: 700g when full



190g PIERCEABLE CARTRIDGE

- Butane/Propane gas mix; standard international 190g pierceable gas cartridge.
- Includes self sealing internal leakage limiter
- Ideal for home use, camping, fishing, picnicking or hiking.

Code: CA190N Weight: 260g when full

227g BUTANE CARTRIDGE NOZZLE TYPE

Portable Butane gas cartridge, fitted with a bayonet connection (SSN-29 valve).

Code: CAN220G Weight: 325g when full



PRODUCT ACCESSORIES



BBQ COVER

- Heavy duty & UV resistant vinyl BBQ cover
- Drawstring closures

98185 - 56 x 70 cm COVER

98190 - 70 x 70 cm COVER

740-CVR GRILLO CHEF BBQ COVER

- Durable cover for CADAC Grillo Chef
- Size: ø 45 x 35 cm



8910-107

LEG BAG

- Storage bag for Carri Chef, Grillo Chef & Braai Range BBQ's legs
- Drawstring top with push fit lock
- Size: ø 13 x 80 cm



6540-800

SAFARI CHEF COVER

- Durable, vinyl BBQ cover, designed for the Safari Chef
- This cover can be tied with a cord
- Size: ø 30 cm



20162-100

CITI CHEF 50 BBQ COVER

- Heavy-duty, weatherproof vinyl BBQ cover
- Designed to fit and protect the Citi Chef 50 gas BBQ
- Size: 80 x 60 x 92 cm

20163-100
MERIDIAN WOODY BBQ COVER

- Heavy duty & UV resistant vinyl BBQ cover
- Velcro closures
- Designed to fit and protect the Meridian Woody BBQ
- Size: 115 x 65 x 95 cm



MERIDIAN BUILT-IN BBQ COVER

- Heavy duty & UV resistant vinyl BBQ cover
 - Velcro closures
 - Designed to fit and protect the Meridian Built-in range of BBQ's
- 982231-100 - 3 BURNER COVER (73 x 62 x 43 cm)
 982241-100 - 4 BURNER COVER (90 x 62 x 43 cm)



PATIO GAS BBQ COVER

- Heavy duty & UV resistant vinyl BBQ cover
 - Velcro closures
 - Designed to fit and protect Entertainer & Meridian range of BBQ's
- 98361 - 3 BURNER COVER (151 x 110 x 61 cm)
 98362 - 4 BURNER COVER (166 x 110 x 61 cm)



8626
CHEF BBQ COVER

- Full-length and UV-resistant vinyl BBQ cover
- Heavy duty cover
- Designed to fit and protect any 47 cm BBQ all year round
- Size: ø 47 cm



- 5650-500
GRILLO CHEF LEG LEVELLER
- Adjust and level your Grillo Chef BBQ
 - Also suited for the Braai Range BBQs



- 8910-111
CARRI CHEF LEG LEVELLER
- Adjust and level your Carri Chef BBQ



98323V
2 HOOK UTENSIL HOLDER

- Stainless steel utensil holder
- Suitable for any round BBQ with diameter of 40-50cm
- Suitable for CADAC Carri Chef, Grillo Gas, Grillo Chef and Braai range
- Dishwasher safe
- Size: 9 x 4.45 x 3.6 cm

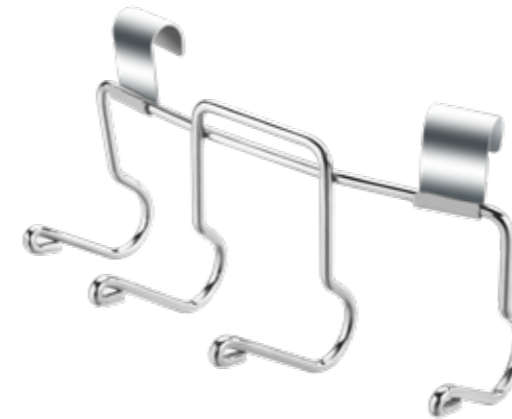

98151
UNIVERSAL TOOL HOLDER

- Keep your tongs, spatulas and essential tools close to hand with this handy tool holder
- Simply hooks onto the side of the kettle BBQ



8631
NON-STICK SKOTTEL® LINER

- Cook food perfectly and healthily
- Use wooden or plastic cooking utensils
- Do not use an open grill or with an open fire, heating elements or burners
- Easy to clean
- Dishwasher safe
- Size: ø 47 cm



8910-SP031
SKOTTEL® FOOD WARMERS

- Material: enameled food separators
- Slip onto the Skottelbraai
- Keep food warm and separate on the outer side
- Set of 2



6544-100
25CM PIZZA STONE

- Size: ø 25 cm
- 1.2 cm thick baking stone
- Can be used in electrical ovens, charcoal kettles, gas BBQs
- Can withstand temperatures of 300°C

98368
33CM PIZZA STONE

- Size: ø 33 cm
- 1,2 cm thick baking stone
- Can be used in electrical ovens, charcoal kettles, gas BBQs
- Can withstand temperatures of 300°C
- Includes chrome plated wire holder



98331
42CM PIZZA STONE

- Size: ø 42 cm
- 1.5 cm thick baking stone
- Can be used in electrical ovens, charcoal kettles, gas BBQs
- Can withstand temperatures of 300°C
- Includes chrome plated wire holder

98425
PIZZA STONE PRO 30

- Size: ø 25 cm
- 1,2 cm thick baking stone
- Can be used in electrical ovens, charcoal kettles, gas BBQs
- Can withstand temperatures of 300°C +
- Heat distributor tray for optimal performance
- Storage bag included



98433
PIZZA STONE PRO 40

- Size: ø 33 cm
- 1,2 cm thick baking stone
- Can be used in electrical ovens, charcoal kettles, gas BBQs
- Can withstand temperatures of 300°C +
- Heat distributor tray for optimal performance
- Storage bag included

98436
PIZZA STONE PRO 50

- Size: ø 36 cm
- 1,2 cm thick baking stone
- Can be used in electrical ovens, charcoal kettles, gas BBQs
- Can withstand temperatures of 300°C +
- Heat distributor tray for optimal performance
- Storage bag included



CADAC PAELLA PAN

CADAC
CITI CHEF 50

GENERAL ACCESSORIES

PAELLA PANS:

8635

PAELLA PAN 30

- Size: ø 28 cm
- Material: Thick aluminium GreenGrill ceramic coated non-stick pan
- Stainless steel lid included
- Easy to clean
- Can be used on an a gas or electric hob
- Storage bag included



8600-100

PAELLA PAN 40

- Size: ø 36 cm
- Material: Thick aluminium GreenGrill ceramic non-stick coated pan
- Easy to clean
- Can be used on an a gas or electric hob
- Storage bag included

5758

PAELLA PAN 50

- Size: ø 47 cm
- Material: Thick aluminium GreenGrill ceramic non-stick coated pan
- Easy to clean
- Can be used on an a gas or electric hob
- Storage bag included



98309V

SPATULA & FORK SET

- Material: stainless steel & heat resistant nylon
- Set includes spatula and fork
- Dishwasher safe

98310V

BBQ SPATULA

- Material: high grade stainless steel
- Cushioned, nonslip handles and thumb rests
- Dishwasher safe



98306V

BBQ FORK

- Material: high grade stainless steel
- Cushioned, nonslip handles and thumb rests
- Dishwasher safe



98308V

NYLON SPATULA

- Material: heat resistant nylon
- Ergonomic handle design
- Elevated utensil rest for improved hygiene
- Dishwasher safe

98311V

BBQ TONGS

- Material: brushed stainless steel
- Locks in closed position for easy storage.
- Large hanging loop
- Cushioned, nonslip handles and thumb rests
- Dishwasher safe



98320V

28CM SILICONE TONGS

- Material: brushed stainless steel and silicone
- Locks in closed position for easy storage.
- Hanging loop
- Cushioned, nonslip handles and thumb rests
- Dishwasher safe



983019V

36CM SILICONE TONGS

- Material: brushed stainless steel and silicone
- Locks in closed position for easy storage.
- Hanging loop
- Cushioned, nonslip handles and thumb rests
- Dishwasher safe

98318V

BBQ SKEWER SET

- 6 re-usable stainless steel skewers
- Individually designed shapely grips for personal identification
- Length: 30 cm

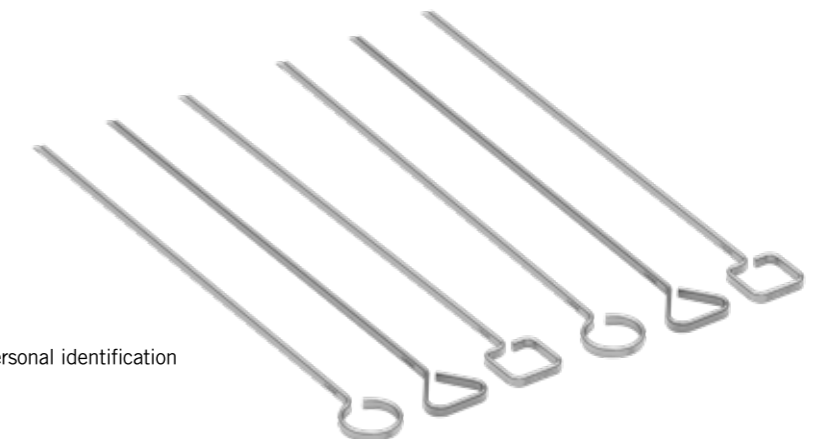



98315V
GRILL PAN

- Material: high grade stainless steel
- Works on all charcoal, gas and electric grills
- Perfect for grilling delicate foods like seafood

98307V
BAMBOO CUTTING BOARD

- Material: Bamboo
- Naturally antimicrobial
- It won't become permeated with the smell of food



98317V
STAINLESS STEEL PIZZA LIFTER

- Material: high grade stainless steel
- Comfortable grip handle
- Dishwasher safe



98399
TAPAS SET

- Material: GreenGrill coated aluminium
- Easy to clean
- Light-weight
- Can be used in BBQs, small gas hobs or any camp stove



98313V
BURGER PRESS

- Size: ø 11 cm
- Material: aluminium with GreenGrill non-stick coating
- Creates hamburger patties consistent in shape, size and weight

8629
BARBECUE CLEANER

- Effective cleaner to clean all chrome and enamelled parts of the BBQ
- Contains 400ml



98304V
GRILL SCRUBBER - 30CM

- Size: 30 cm long
- Easily cleans cast iron grills
- Bristles are long wearing
- Will not scratch porcelain enamel



98303V
GRILL SCRUBBER - 45CM

- Size: 45 cm long
- Easily cleans cast iron grills
- Bristles are long wearing
- Will not scratch porcelain enamel



98305V
GRILL SCRUBBER - 20CM

- Size: 20 cm long
- Material: stainless steel bristles and a steel scraper
- Removes tough baked on grease from cooking grills



98397-2
GRILL SCRUBBER - 40CM

- Stainless steel with softgrip handle
- Copper durable bristles
- Dishwasher safe
- Integrated bottle opener



98302V
GREENGRILL BRUSH

- Material: natural Palmyra plant fibers
- Clean CADAC GreenGrill ceramic coatings
- Bristles are strong, durable, and heat resistant
- Suitable for cleaning any ceramic, chrome, cast iron and enamelled tops



98314V
CHARCOAL RAKE

- Safely and conveniently arrange lit charcoal
- Hanging loop for convenient hanging on kettle BBQs

2017001
BLUETOOTH THERMOMETER

- Magnetic with LED display
- Fully digital
- Compatible with iOS & Android devices
- Download free app on Play Store / Apple Store



98301V
IO LED CLAMPER LIGHT

- 10 Led Grill Lights
- See your grill perfectly
- Clamps onto grill handles & poles

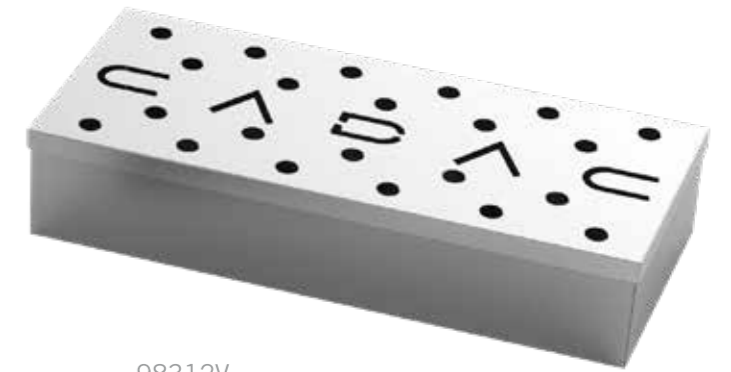

98312V
SMOKER BOX

- Material: thick gauge stainless steel
- Durable and easy to clean
- For an earthy, natural flavor

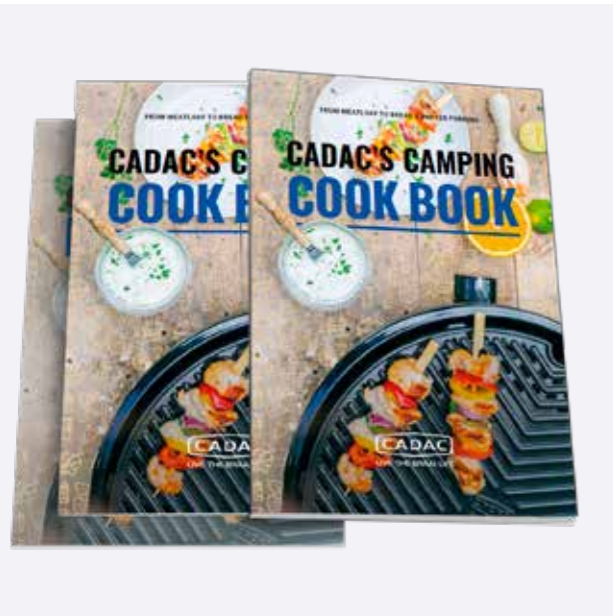

40761
CAMPING COOK BOOK

- Contains 30 simple & inspiring barbecue recipes. Consisting of meat, fish, vegetarian and desserts
- Easy recipes to make on the campsite or on the go
- All of the recipes are made on CADAC barbecues and different cooking tops
- Available in English, German, Dutch & French



98316V
MINI SMOKER BOX

- Material: thick gauge stainless steel
- Fits Citi Chef 50, Citi Chef 40, Carri Chef and Grillo Chef
- Durable and easy to clean
- For an earthy, natural flavor

2015013
ROUND GRILLMAT

- Size: ø 52 cm
- For all chromed & enameled parts of the BBQ
- Non-stick coating
- Easy to clean and use
- Dishwasher safe



2015012
RECTANGULAR GRILLMAT

- Size: 33 x 40 cm
- For all chromed & enameled parts of the BBQ
- Non-stick coating
- Easy to clean and use
- Dishwasher safe

98388
WOK

- Material: anodized aluminium with GreenGrill ceramic coating and a stainless steel handle
- Easy to clean
- Can be used in BBQs, gas hobs or any camp stove/BBQ



PRODUCT SPECIFICATIONS

SAFARI CHEF 30 RANGE				
	SAFARI CHEF 30 HP		SAFARI CHEF 30 LP	
PRODUCT FEATURES				
Product Code	6540H1-10	6540H1-20	6540L1-10	6540L1-20
Power Output	1.82 kW		1.8 kW	
Gas Consumption	132 grams/h		130 grams/h	
Operating Pressure	Vapour Pressure LPG		28-30mbar / 37mbar / 50mbar	
IGNITION				
Automatic Piezo Ignition	✓	✓	✓	✓
SURFACES INCLUDED				
Pot Stand	✓	✓	✓	✓
BBQ Grid (GreenGrill)	✓	✓	✓	✓
Fat Pan	✓	✓	✓	✓
Lid/Dome	✓	✓	✓	✓
Flat Grill (GreenGrill)	✓		✓	
Ribbed Grill (GreenGrill)				
Skottel				
Paella Pan (GreenGrill)				
Grill 2 Braai (GreenGrill)				
BBQ/Plancha (GreenGrill)				
Chef Pan (GreenGrill)				
COOKING DIMENSIONS				
Cooking Area (diameter cm)	ø 28cm BBQ grid, ø 26cm Flat Grid, ø 27cm Dome / Pot	ø 28cm BBQ grid, ø 27cm Dome / Pot	ø 28cm BBQ grid, ø 26cm Flat Grid, ø 27cm Dome / Pot	ø 28cm BBQ grid, ø 27cm Dome / Pot
DIMENSIONS				
Assembled	38.8 x 22 x 22	38.8 x 22 x 22	38.8 x 22 x 22	38.8 x 22 x 22
Packed	32.6 x 32.6 x 22.5	32.6 x 32.6 x 22.5	32.6 x 32.6 x 22.5	32.6 x 32.6 x 22.5
PRODUCT WEIGHT				
Assembled	4	3.6	4	3.6
Packed	5.2	4.7	5.2	4.7
GAS SUPPLY OPTIONS				
LPG Cylinder	✓ (with use of Adapter set)	✓ (with use of Adapter set)	✓	✓
Dual PowerPak			✓	✓
Trio PowerPak			✓	✓
EN417 Threaded Gas Cartridge	✓	✓	✓	✓
227g Cartridge				
WARRANTY (YEARS)				
	2	2	2	2

PRODUCT SPECIFICATIONS

SAFARI CHEF 30 RANGE		GRILLO CHEF 40 RANGE		CARRI CHEF 50 RANGE		
SAFARI CHEF COMPACT 30		GRILLO CHEF 40		CARRI CHEF 50		
6525L1-10-UN	6525L1-20-UN	5650-20	5650-41	8910-20	8910-30	
1.8 kW	1.8 kW	3,7 kW		3,7kW		
130 grams/h	130 grams/h	270 grams/h		270 grams/h		
28-30mbar / 37mbar / 50mbar	28-30mbar / 37mbar / 50mbar	28-30mbar / 37mbar / 50mbar		28-30mbar / 37mbar / 50mbar		
✓	✓	✓	✓	✓	✓	
✓	✓	✓	✓	✓	✓	
✓	✓	✓	✓	✓	✓	
✓	✓	✓	✓	✓	✓	
✓						
					✓	
			✓			
ø 28cm BBQ grid, ø 26cm Flat Grid, ø 27cm Dome / Pot		ø 28cm BBQ grid, ø 27cm Dome / Pot	ø 38cm BBQ grid	ø 38cm BBQ grid, ø 36cm Chef Pan	ø 46cm BBQ Top	ø 48.6cm Skottel® Top ø 46cm BBQ Top
23 x 34.7 x 30.4	23 x 34.7 x 30.4	65.4 x 65.4 x 88.5	65.4 x 65.4 x 71	69.6 x 69.6 x 93.4	69.6 x 69.6 x 93.4	
		42.2 x 20.5 x 57.3	42.2 x 22 x 57.3	32.7 x 56.6 x 57.2	32.7 x 56.6 x 57.2	
3.8	3	8	9.3	12	13	
5.2	4.2	9	10.2	15	16	
		✓	✓	✓	✓	
		✓	✓	✓	✓	
		✓	✓	✓	✓	
✓	✓					
2	2	2	2	2	2	

PRODUCT SPECIFICATIONS

	€ BRAAI	CITI CHEF RANGE		
	€ BRAAI	CITI CHEF 40	CITI CHEF 40 FS	CITI CHEF 50
PRODUCT FEATURES				
Product Code	5840-20	5610-20	5615-20	20162-20
No. of Burners	1	1	1	1
Power Output	2,3 kW	2,7 kW	2,7 kW	3,7 kW
Operating Pressure		28-30mbar / 37mbar / 50mbar	28-30mbar / 37mbar / 50mbar	28-30mbar / 37mbar / 50mbar
Automatic Piezo Ignition		✓	✓	✓
COOKING DIMENSIONS				
Cooking dimensions (L x W)(ø)(cm)	ø 39 cm	ø 39 cm	ø 39 cm	ø 46 cm
COOKING SURFACE				
Porcelain Enamelled Rolled Steel				
Ceramic Coated Diecast Aluminium	✓	✓	✓	✓
ADDITIONAL FEATURES				
Thermogrid				
Dome Thermometer		✓	✓	✓
Warming Rack				
Tool Holder			✓	✓
Gas Supply Storage			✓	✓
Maneuvering Handles				✓
BODY				
Side Tables			✓	✓
Stainless Steel Dome				
SURFACES INCLUDED				
Thermogrid				
BBQ Grid	✓	✓	✓	✓
DIMENSIONS (LXBXH)				
Assembled	48 x 35.5 x 44.5	42,2 x 42,2 x 33,4	72 x 94.6 x 45.5	88 x 55 x 102,3
Packaged	53 x 53 x 33	47,3 x 49,3 x 36,8	69 x 48 x 35,5	76 x 66 x 38
WEIGHT (KG)				
Assembled	8,05	7,1	11,4	20
Packaged	10,1	9,1	13,8	24
COLOURS				
	Black, Petrol	Black, Olive Green, Sky Blue	Black, Flint Grey	Grey
WARRANTY (YEARS)				
	5	5	5	5

MERIDIAN RANGE	
MERIDIAN 3B BUILT-IN	MERIDIAN 4B BUILT-IN
982231	982241
3	4
9,6 kW	12,4 kW
28-30mbar / 37mbar / 50mbar	28-30mbar / 37mbar / 50mbar
✓	✓
64 x 48.5	80 x 48.5
✓	✓
✓	✓
✓	✓
✓	✓
✓	✓
✓	✓
71 x 60 x 51	86 x 60 x 51
76 x 64 x 56	91 x 64 x 56
27	31
31	35
Stainless Steel	Stainless Steel
5	5



PLEASE NOTE THAT PRODUCTS MAY VARY FROM ILLUSTRATIONS

CADAC

LIVE THE BRAAI LIFE

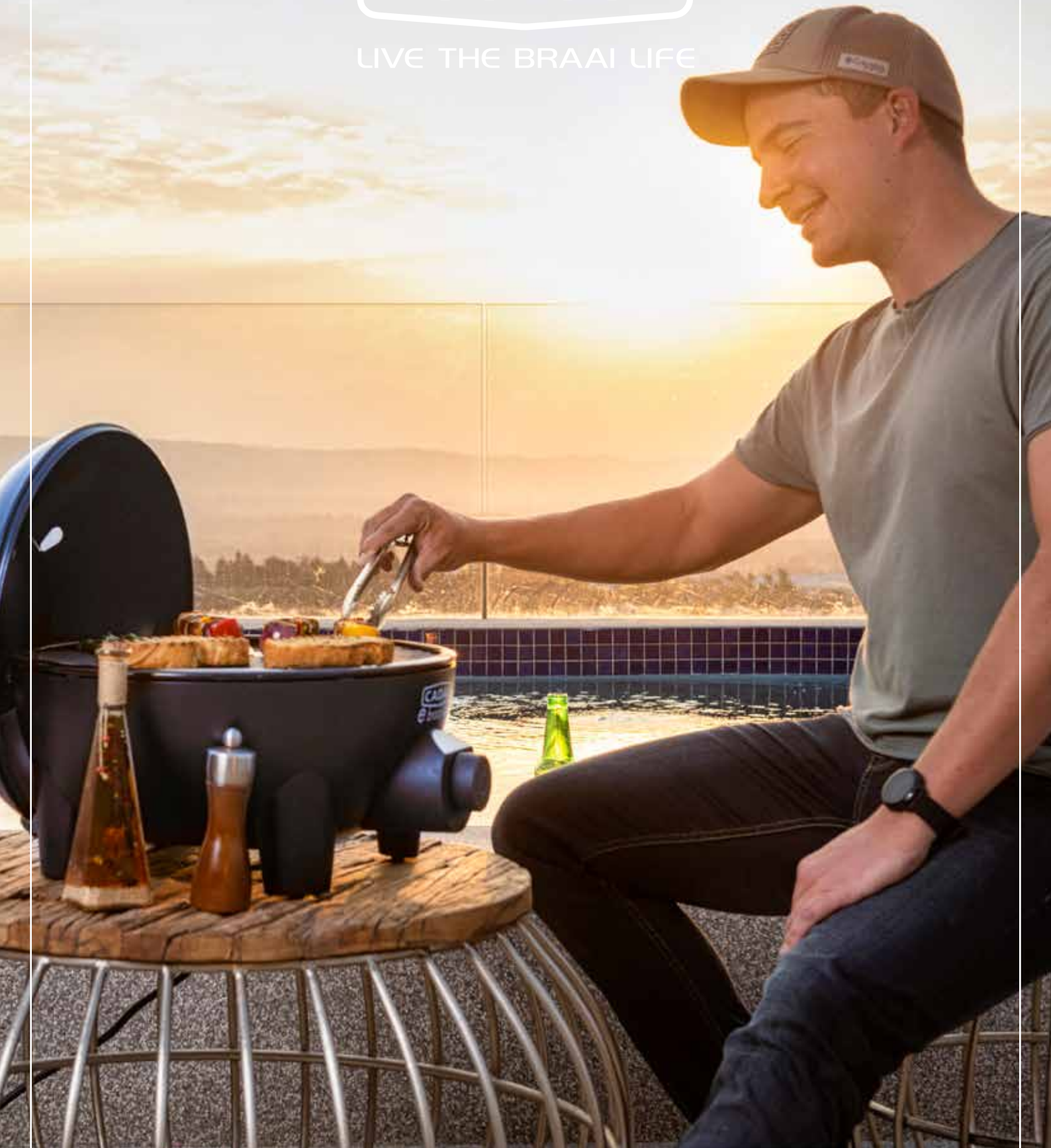

CADAC EUROPE

Ratio 26, 6921 RW Duiven

The Netherlands

Tel: +31 26 319 7740

Email: info@cadaceurope.com

www.cadacinternational.com